

Model No.DUH601 600MM CORDLESS HEDGE TRIMMER

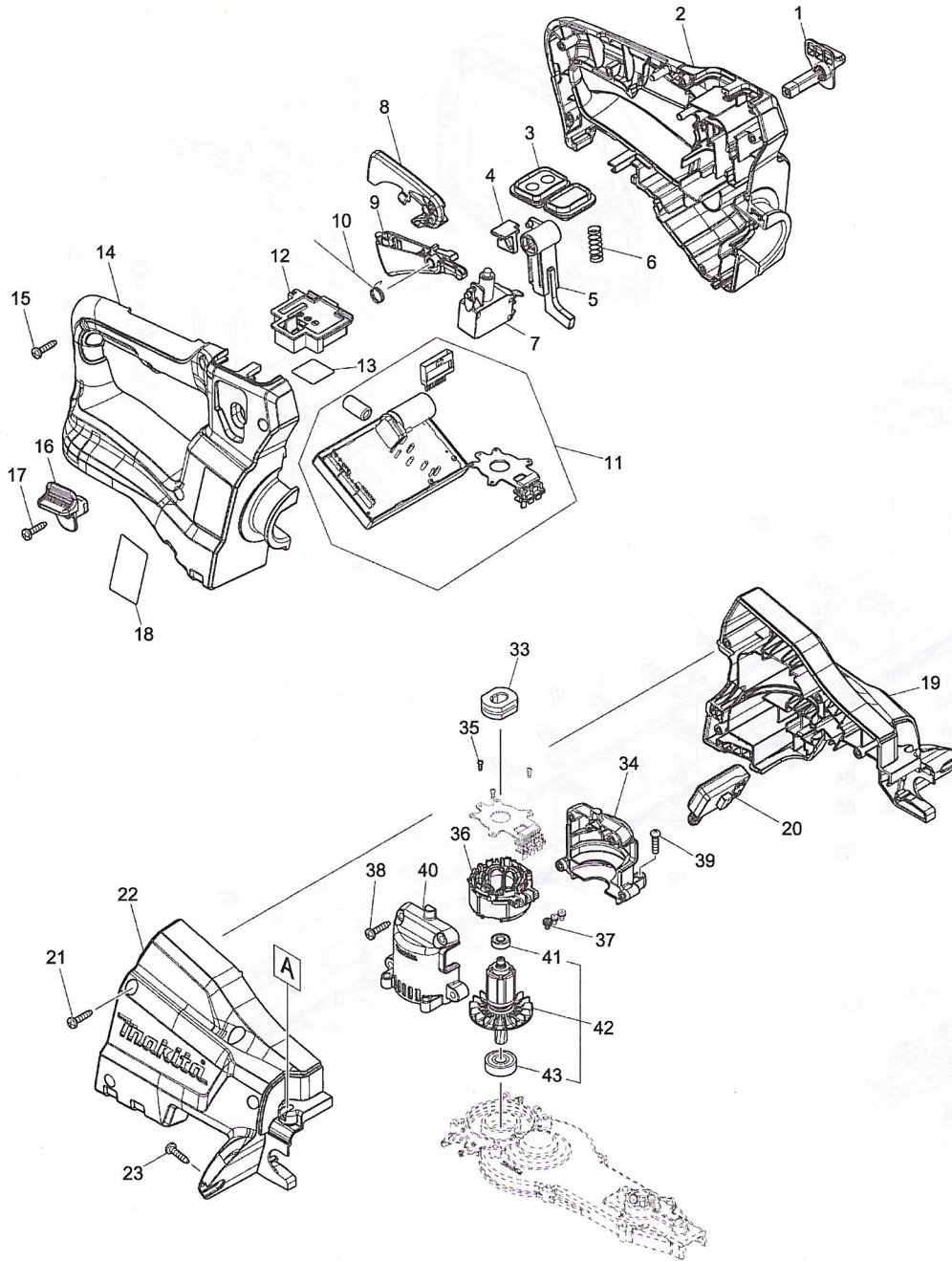

Model No. DUH601 600MM CORDLESS HEDGE TRIMMER

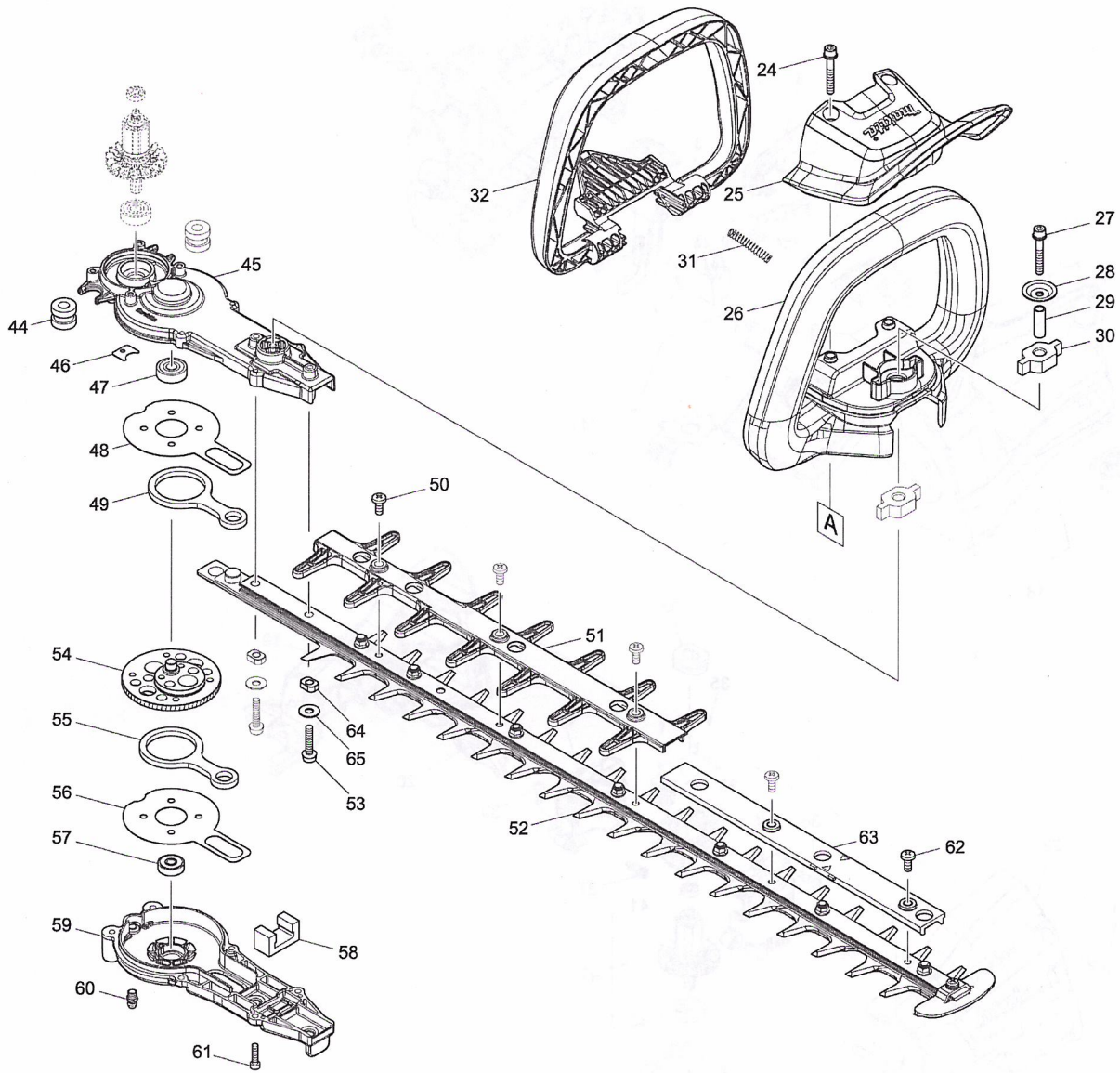

Model No.DUH601 600MM CORDLESS HEDGE TRIMMER

Item	Parts No.	Description	I/C	QTY	New/Old	Opt. 1	Opt. 2	NOTE
001	458406-0	LOCK LEVER L		1				
002	183J51-9	HANDLE SET		1				
C10	263005-3	RUBBER PIN 6		2		100		
D10		INC. 14						
003	140A04-7	SUB CONTROLLER COMPLETE		1				
C10	806G56-1	INDICATION LABEL		1				
C20	817C42-3	SWITCH LABEL		1				
004	458570-7	SLIDER		1				
005	458405-2	LOCK ARM		1				
006	234204-4	COMPRESSION SPRING 8		1		100		
007	650781-2	SWITCH C3JW-6B-P		1				
008	458403-6	LOCK OFF LEVER		1				
009	458404-4	SWITCH LEVER R		1				
010	232454-5	TORSION SPRING 10		1				
011	620818-9	CONTROLLER		1				
012	644809-6	TERMINAL		1				
013	854K10-3	DUH601 SERIAL NO. LABEL		1				
014	183J51-9	HANDLE SET		1				
C10	263005-3	RUBBER PIN 6		2		100		
D10		INC. 2						
015	266326-2	TAPPING SCREW 4X18		6		100		
016	458407-8	LOCK LEVER R		1				
017	266326-2	TAPPING SCREW 4X18		1		100		
018	854K03-0	DUH601 NAME PLATE		1				
019	183K21-4	HOUSING SET		1				
C10	252143-6	COLLARED HEX.NUT M5-8		2				
C20	424344-8	DAMPER		4		100		
D10		INC. 22						
020	651083-9	SWITCH C3XA-1PSPM		1				
021	266326-2	TAPPING SCREW 4X18		4		100		
022	183K21-4	HOUSING SET		1				
C10	252143-6	COLLARED HEX.NUT M5-8		2				
C20	424344-8	DAMPER		4		100		
D10		INC. 19						
023	266326-2	TAPPING SCREW 4X18		2		100		
024	265182-7	+ PAN HEAD SCREW M5X25		2		100		
025	458399-1	PROTECTOR		1				
026	458400-2	FRONT GRIP E		1				
027	251476-6	H.S.H.BOLT M5X35 WITH WR		1				
028	253416-0	DISH WASHER 5		1				
029	257678-2	SLEEVE 6		1				
030	422260-8	RUBBER SLEEVE 8		2				
031	233222-9	COMPRESSION SPRING 5		1	*			
031-1	233222-9	COMPRESSION SPRING 5	O	2				
032	458402-8	SWITCH LEVER F		1				

Please order the parts with part number.

Print Date 5/11/2019

Model No.DUH601 600MM CORDLESS HEDGE TRIMMER

Item	Parts No.	Description	I/C	QTY	New/Old	Opt. 1	Opt. 2	NOTE
033	422261-6	RUBBER SLEEVE		1				
034	183J52-7	MOTOR HOUSING SET		1	*			
D10		INC. 40			*			
034-1	183L66-8	MOTOR HOUSING SET	<	1				
D10		INC. 40						
035	266490-9	TAPPING SCREW PT 2X6		3				
036	629352-6	STATOR		1				
037	652069-6	FLAT HEAD SCREW M3X6		3				
038	266326-2	TAPPING SCREW 4X18		4		100		
039	265178-8	PAN HEAD SCREW M4X16		4		100		
040	183J52-7	MOTOR HOUSING SET		1	*			
D10		INC. 34			*			
040-1	183L66-8	MOTOR HOUSING SET	<	1				
D10		INC. 34						
041	211157-4	BALL BEARING 695ZZ		1				
042	519522-4	ROTOR ASSY		1	*			
D10		INC. 41,43			*			
042-1	519557-5	ROTOR ASSY	<	1				
D10		INC. 41,43						
043	211032-4	BALL BEARING 608ZZ		1		100		
044	422259-3	RUBBER SLEEVE 8		2				
045	140F22-5	GEAR HOUSING COMPLETE		1				
C10	424344-8	DAMPER		1		100		
046	458417-5	GASKET		1				
047	211032-4	BALL BEARING 608ZZ		1		100		
048	347361-0	FRICTION PLATE		1				
049	347362-8	CONNECTING ROD		1				
050	915211-3	BINDING HEAD SCREW M5X12		3		100		
051	458408-6	GUARD E		1				
052	199099-1	SHEAR BLADE ASSEMBLY 600 SET		1	*			
C10	345205-8	BRANCH CATCHER		1	*	100		
C20	911208-0	PAN HEAD SCREW M5X10		1	*	100		
052-1	199099-1	SHEAR BLADE ASSEMBLY 600 SET	<	1				
C10	345205-8	BRANCH CATCHER		1		100		
C20	911208-0	PAN HEAD SCREW M5X10		1		100		
053	265182-7	+ PAN HEAD SCREW M5X25		2		100		
054	140B79-2	GEAR COMPLETE		1				
055	347362-8	CONNECTING ROD		1				
056	347361-0	FRICTION PLATE		1				
057	211499-6	BALL BEARING 626ZZ		1				
058	443159-4	SEAL		1		154		
059	140B62-9	GEAR HOUSING COVER COMPLETE		1				
060	266559-9	H.S.BUTTON HEAD BOLT M6X4		1				
061	265490-6	HEX. SOCKET HEAD BOLT M4X16		6	*	100		

Please order the parts with part number.

Print Date 5/11/2019

Model No.DUH601 600MM CORDLESS HEDGE TRIMMER

Item	Parts No.	Description	I/C	QTY	New/Old	Opt. 1	Opt. 2	NOTE
061-1	266437-3	HEX. SOCKET HEAD BOLT M4X16	<	6		100		
062	915211-3	BINDING HEAD SCREW M5X12		2		100		
063	458628-2	SPACER 600		1				
064	257439-0	SLEEVE 5		2				
065	253804-1	FLAT WASHER 6		2		100		
A01	458414-1	BLADE COVER 600		1				
A02	195246-2	SAFETY GOGGLE		1	*			

Please order the parts with part number.

Print Date 5/11/2019